

Visys Spyder[®]

Digital Laser Sorter

Features & Benefits

- Color, structure, shape
- Multi-spectral laser technology
- Full product viewing with front and rear lasers
- Proprietary Chycane[®] chute-fed for optimum product control
- Small footprint
- Easy to use GUI
- No moving parts – Low maintenance
- Sanitary design compliant – Full stainless steel/IP65
- 100% digital FPGA technology
- Full remote service via Internet
- Fully modular, retrofittable and upgradeable

Uncompromised Sorting

The Spyder[®] Digital Laser Sorter offers you an uncompromised combined sorting experience for detection and ejection of foreign material, EVM and defects based on color, structure, shape and size differences.

Improve Product Quality

The Spyder[®] is a 100% digital sorter. Data is digitized immediately upon inspection to eliminate any loss of information ensuring significantly higher ejection accuracy. False rejects are limited to an absolute minimum improving quality.

Improve Yield

The proprietary Chycane[®] chute feeds the product in a perfect monolayer with a consistent trajectory to the laser optics and ejection valves. This optimized product control maximizes sorting and ejection efficiency, increasing yield.



Spyder[®] 1200

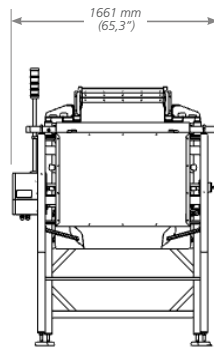
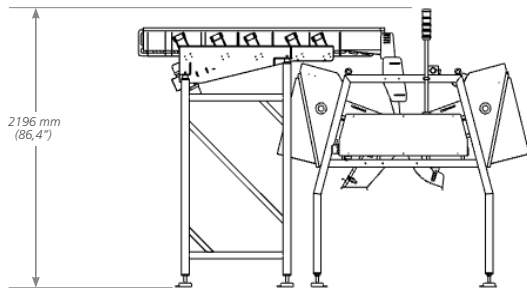
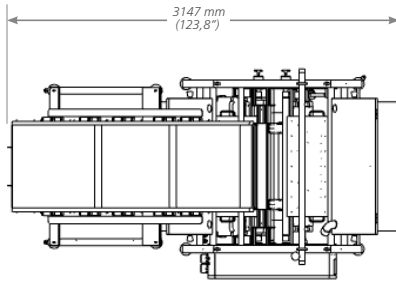

Spyder® 680

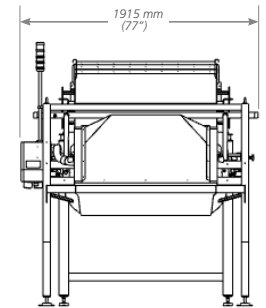
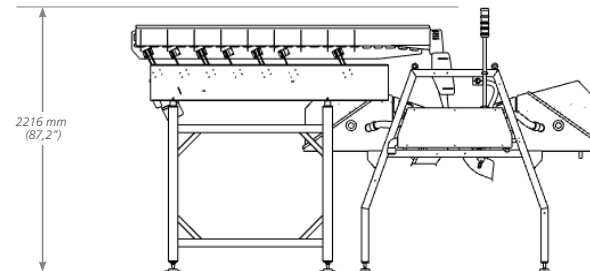
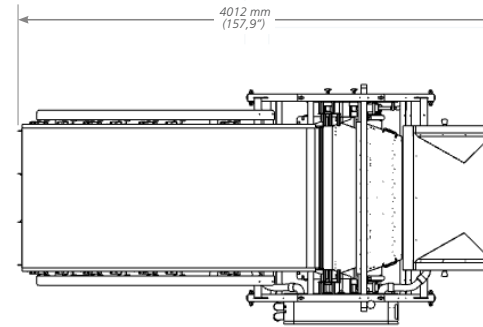

Spyder® 1200

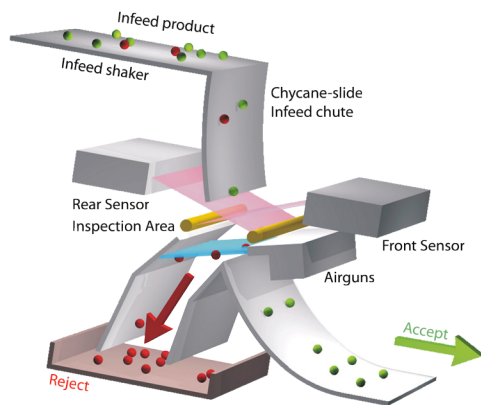

Patented Chycane® Chute working principle

Typical Applications

Dried fruit, frozen fruits & vegetables, nuts, confections, coffee and snack foods.

Sorting Excellence

With more than 100 Spyder® Digital Laser Sorters installed around the world on a multitude of applications, the Spyder® has proven to be a reliable sorter helping food processors to optimize their product quality, safety and overall yield.

Results

Reliability, improved yields, improved product quality and safety.

Capacity

Spyder®680: up to 5 metric tons/hour *
Spyder®1200: up to 10 metric tons/hour *

*Depending on product and defect load